

Lattices and non-perturbative field theory

Michael Creutz
Brookhaven Lab & U. Mainz



The lattice provides a first principles “solution” of hadronic physics

- Basic formulation: Wilson 1974
- 1980's: grew into a major industry
- Dominated by computer simulations
- Annual lattice conference: 300 participants

Now the primary source of non-perturbative information for QCD

What drove us to lattice Monte Carlo?

Late 1960's

- quantum electrodynamics: immensely successful, but “done”
- eightfold way: “quarks” explain particle families
- electroweak theory emerging
- electron-proton scattering: “partons”

Meson-nucleon theory failing

- $\frac{g^2}{4\pi} \sim 15$ vs. $\frac{e^2}{4\pi} \sim \frac{1}{137}$
- no small parameter for expansion

Frustration with quantum field theory

“S-matrix theory”

- particles are bound states of themselves
 - $p + \pi \leftrightarrow \Delta$
 - $\Delta + \pi \leftrightarrow p$
- held together by exchanging themselves
- roots of duality between particles and forces \longrightarrow string theory

What is elementary?

Early 1970's

- “partons” \longleftrightarrow “quarks”
- renormalizability of non-Abelian gauge theories
 - 1999 Nobel Prize, G. 't Hooft and M. Veltman
- asymptotic freedom
 - 2004 Nobel prize: D. Gross, D. Politzer, F. Wilczek
- Quark Confining Dynamics (QCD) evolving

Confinement?

- interacting hadrons vs. quarks and gluons
- What is elementary?

Mid 1970's: a particle theory revolution

- J/ψ discovered, quarks inescapable
- field theory reborn
 - “standard model” evolves

Extended objects in field theory

- “classical lumps” a new way to get particles
- “bosonization” very different formulations can be equivalent
- growing connections with statistical mechanics
- What is elementary?

Field Theory >> Feynman Diagrams

Field theory has infinities

- bare charge, mass divergent
- must “regulate” for calculation
- Pauli Villars, dimensional regularization: perturbative
 - based on Feynman diagrams
 - an expansion in a small parameter, the electric charge

But the expansion misses important “non-perturbative” effects

- confinement
- light pions from chiral symmetry breaking

need a “non-perturbative” regulator

Wilson's strong coupling lattice theory (1973)

Strong coupling limit does confine quarks

- only quark bound states (hadrons) can move

space-time lattice = non-perturbative cutoff

Lattice gauge theory

- A mathematical trick
- Minimum wavelength = lattice spacing a
 - Uncertainty principle: a maximum momentum = π/a
- Allows computations
- Defines a field theory

Wilson's strong coupling lattice theory (1973)

Strong coupling limit does confine quarks

- only quark bound states (hadrons) can move

space-time lattice = non-perturbative cutoff

Lattice gauge theory

- A mathematical trick
- Minimum wavelength = lattice spacing a
 - Uncertainty principle: a maximum momentum $= \pi/a$
- Allows computations
- Defines a field theory

Be discrete, do it on the lattice

Wilson's strong coupling lattice theory (1973)

Strong coupling limit does confine quarks

- only quark bound states (hadrons) can move

space-time lattice = non-perturbative cutoff

Lattice gauge theory

- A mathematical trick
- Minimum wavelength = lattice spacing a
 - Uncertainty principle: a maximum momentum = π/a
- Allows computations
- Defines a field theory

Be discrete, do it on the lattice

Be indiscreet, do it continuously

Wilson's formulation

local symmetry + theory of phases

Variables:

- Gauge fields are generalized “phases” $U_{i,j} \sim \exp(i \int_{x_i}^{x_j} A^\mu dx_\mu)$

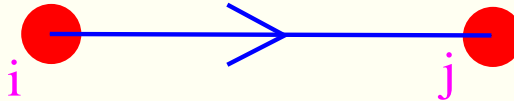

U_{ij} = 3 by 3 unitary ($U^\dagger U = 1$) matrices, i.e. SU(3)

- On links connecting nearest neighbors
- 3 quarks in a proton

Dynamics:

- Sum over elementary squares, “plaquettes”

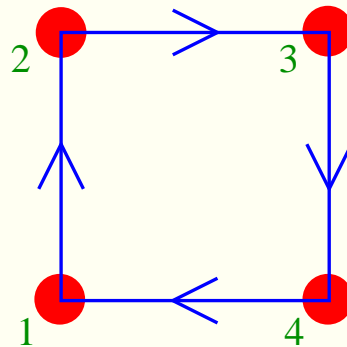

$$U_p = U_{1,2}U_{2,3}U_{3,4}U_{4,1}$$

- like a “curl” $\vec{\nabla} \times \vec{A} = \vec{B}$
- flux through corresponding plaquette.

$$S = \int d^4x (E^2 + B^2) \longrightarrow \sum_p \left(1 - \frac{1}{3} \text{ReTr} U_p \right)$$

Quantum mechanics:

- via Feynman's path integrals
- sum over paths \longrightarrow sum over phases
 - $Z = \int (dU) e^{-\beta S}$
 - invariant group measure

Parameter β related to the “bare” charge

- $\beta = \frac{6}{g_0^2}$
- divergences say we must “renormalize” β as $a \rightarrow 0$
 - adjust β to hold some physical quantity constant

Parameters

Asymptotic freedom

$$g_0^2 \sim \frac{1}{\log(1/a\Lambda)} \rightarrow 0$$

Λ sets the overall scale via “dimensional transmutation”

- Sidney Coleman and Erick Weinberg
- Λ depends on units: not a real parameter

Only the quark masses!

$m_q = 0$: parameter free theory

- $m_\pi = 0$
- m_ρ/m_p determined
- close to reality

Example: strong coupling determined

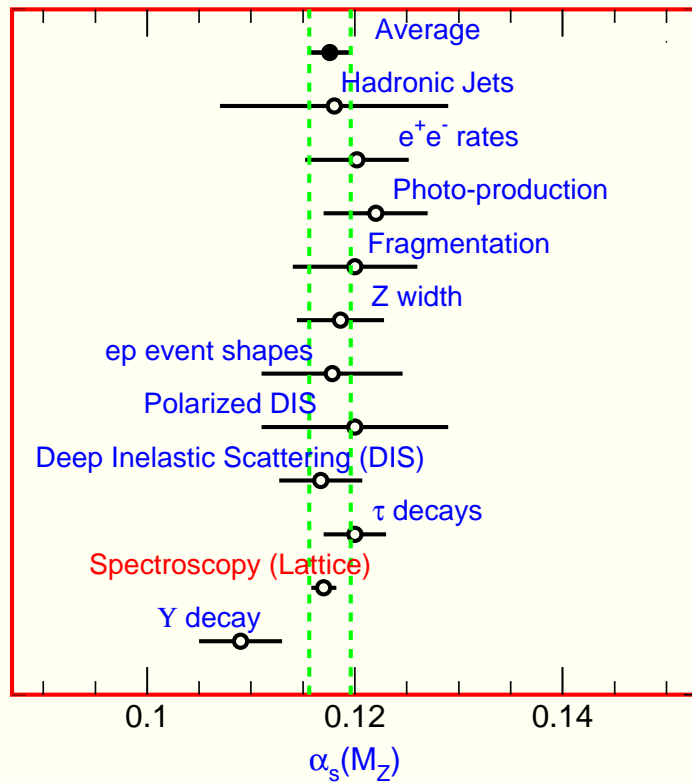

(PDG, 2008)

(charmonium spectrum for input, fermion dynamics treated approximately)

Monte Carlo

Random field changes biased by Boltzmann weight.

- converge towards “thermal equilibrium.”
 - $P(C) \sim e^{-\beta S}$

In principle can measure anything

Fluctuations → theorists have error bars!

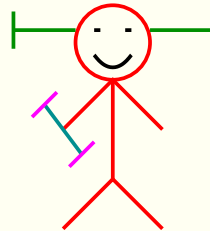

Also have systematic errors

- finite volume
- finite lattice spacing
- quark mass extrapolations

Interquark force

- constant at large distance
- confinement

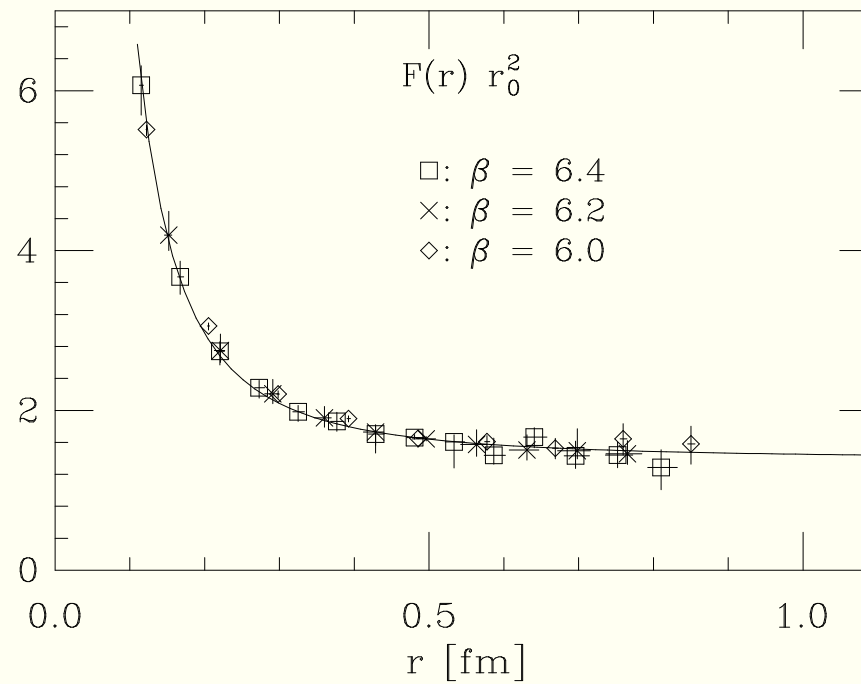

C. Michael, hep-lat/9509090

Extracting particle masses

- let $\phi(t)$ be some operator that can create a particle at time t
- As $t \rightarrow \infty$
 - $\langle \phi(t)\phi(0) \rangle \longrightarrow e^{-mt}$
- $m =$ mass of lightest hadron created by ϕ
- Bare quark mass is a parameter

Chiral symmetry:

$$m_\pi^2 \sim m_q$$

Adjust m_q to get m_π/m_ρ (m_s for the kaon)

all other mass ratios determined

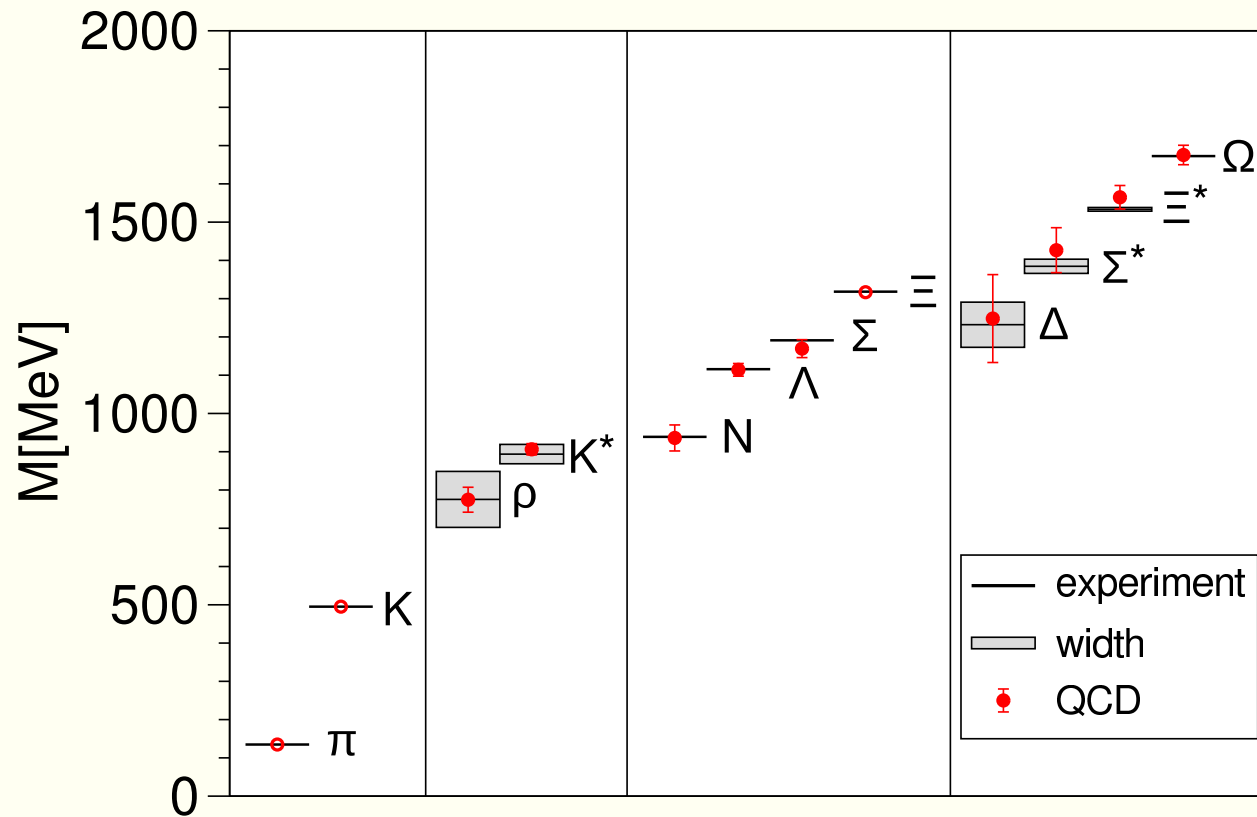

Budapest-Marseille-Wuppertal collaboration

- Science 322:1224-1227,2008
- improved Wilson fermions

Glueballs

- closed loops of gluon flux
- no quarks

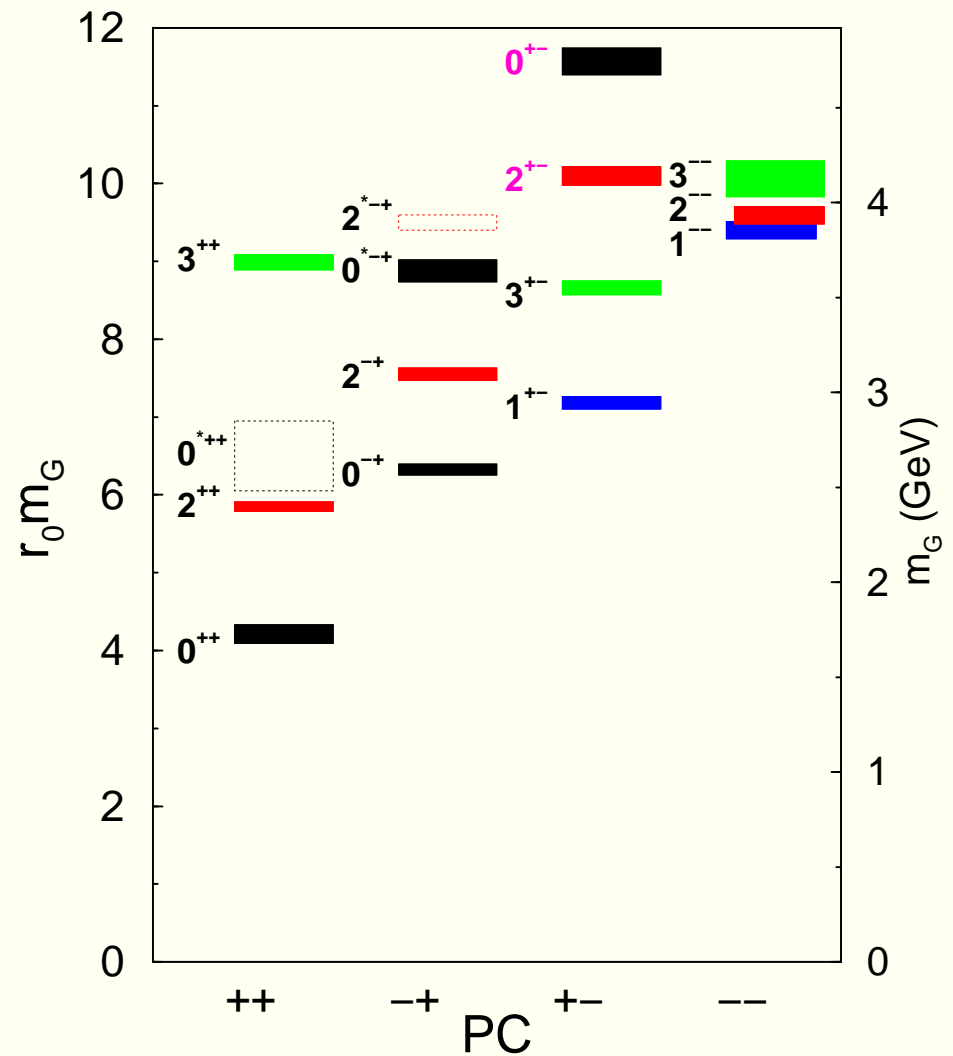

Morningstar and Peardon, Phys. Rev. D 60, 034509 (1999)

- used an anisotropic lattice, ignored virtual quark-antiquark pairs

Quark Gluon Plasma

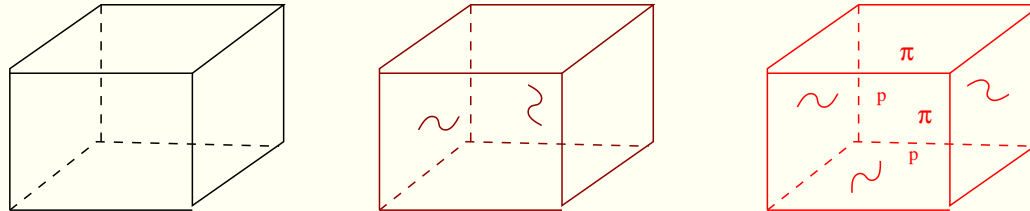

Finite temporal box of length t

- $Z \sim \text{Tr} e^{-Ht}$
- $1/t \leftrightarrow$ temperature
- confinement lost at high temperature
- chiral symmetry restored
- $T_c \sim 170 - 190 \text{ MeV}$
 - not a true transition, but a rapid “crossover”

Big jump in entropy versus temperature

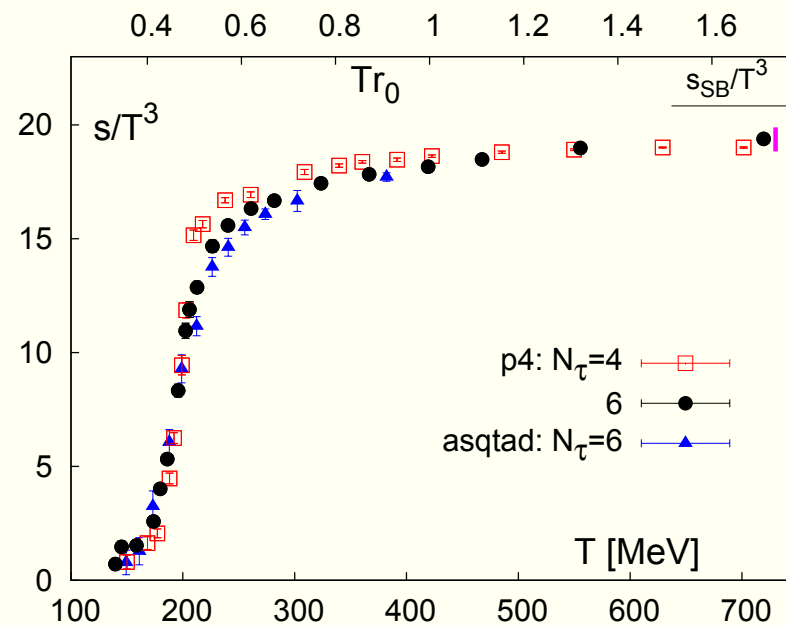

M. Cheng et al., Phys.Rev.D77:014511,2008

- use a non-rigorous approximation to QCD

The Lattice SciDAC Project

Most US lattice theorists; 9 member executive committee:

R. Brower, (Boston U.) N. Christ (Columbia U.), M. Creutz (BNL), P. Mackenzie (Fermilab), J. Negele (MIT), C. Rebbi (Boston U.), D. Richards (JLAB), S. Sharpe (U. Washington), R. Sugar (UCSB)

Two prong approach

- QCDOC at BNL
- commodity clusters at Fermi Lab and Jefferson Lab
- $\sim 3 \times 10$ Teraflops distributed computing facility

QCDOC

- next generation after QCDSP
- designed by Columbia University with IBM
- on design path to IBM Blue Gene
- Power PC nodes connected in a 6 dimensional torus
- processor/memory/communication on a single chip

QCDOC places entire node on a single custom chip

QCDOC ASIC DESIGN

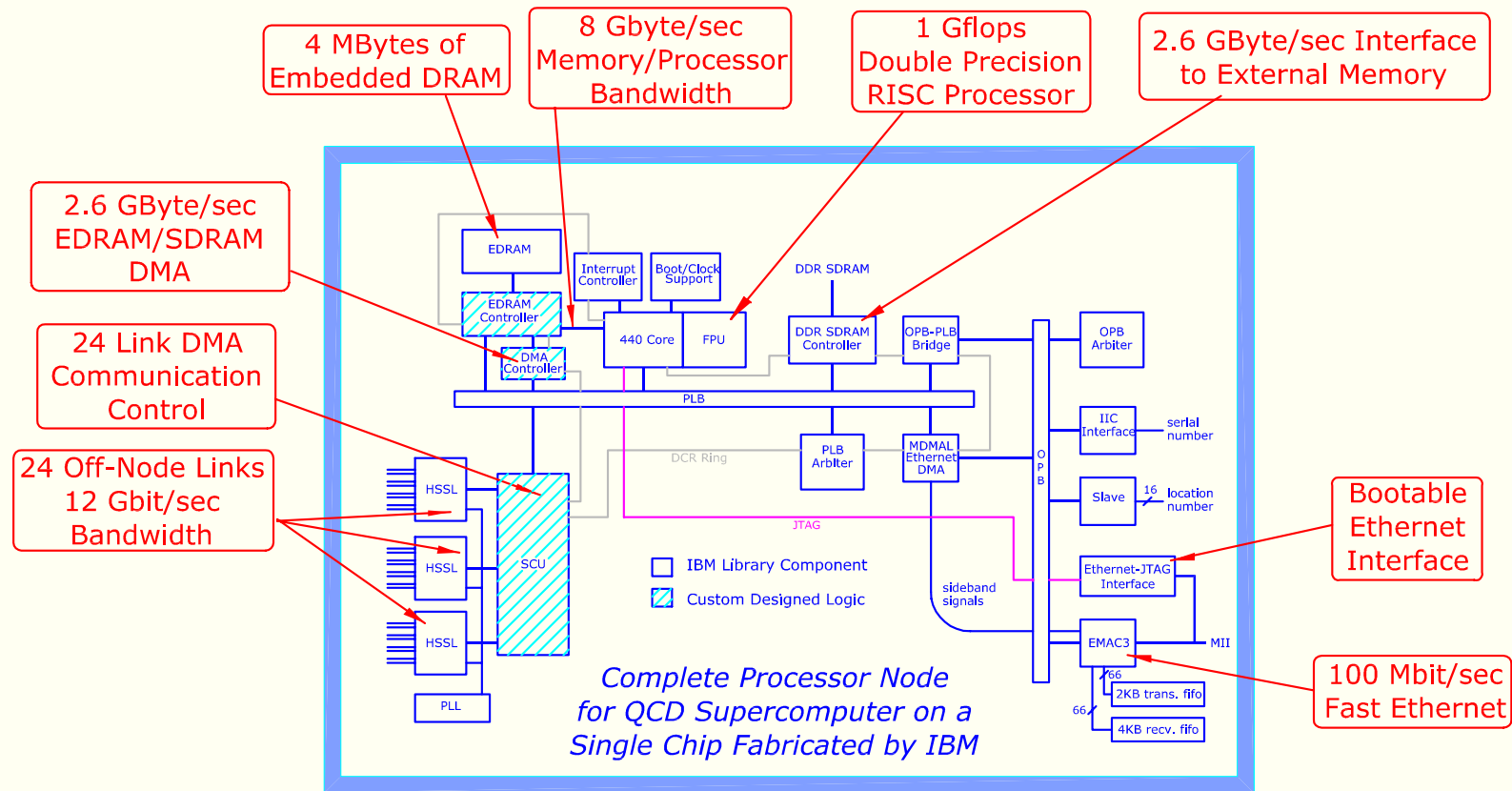

Mission-critical, custom logic (hatched) for high-performance memory access and fast, low-latency off-node communications is combined with standards-based, highly integrated commercial library components.

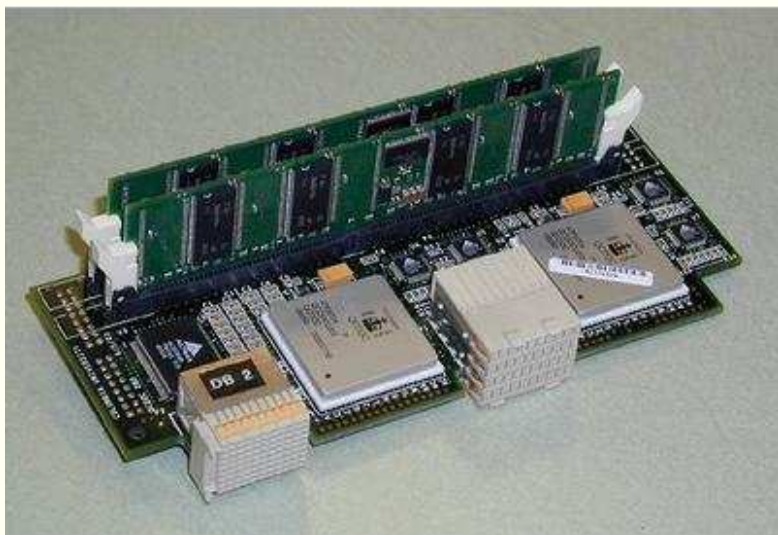

Two node daughterboard



64 node motherboard

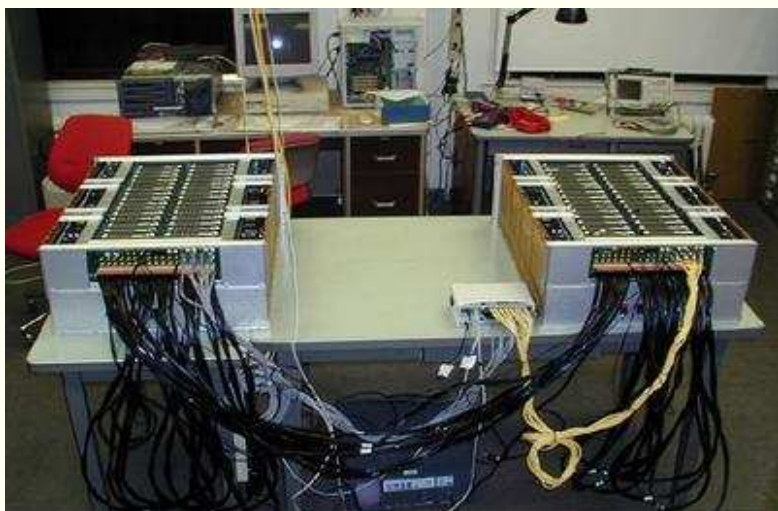

128 node prototype



DOE/RIKEN 24,576 nodes!



Fermilab: 600 nodes with 2.0 GHz Dual CPU Dual Core Opterons



JLAB: 396 nodes of AMD Opteron (quad-core) CPUs

Unsolved Problems

Chiral gauge theories

- parity conserving theories (QCD) in good shape
- chiral theories (neutrinos) remain enigmatic
 - non-perturbative definition of the weak interactions?

Sign problems

- finite baryon density: nuclear matter
 - color superconductivity at high density
- $\theta \neq 0$
 - spontaneous CP violation at $\theta = \pi$

Fermion algorithms (quarks)

- remain very awkward
- why treat fermions and bosons so differently?

Lots of room for new ideas!